

Library eBooks and Your Kindle

Library eBooks now can be read on your Kindle. You need a computer with an Internet connection, and a valid library card. When using your Kindle for the first time, you will need to obtain an account at www.amazon.com and then register your Kindle device. Once you select your eBook from the WLN eMedia site, you will be transferred to www.amazon.com to download the eBook to your computer. The eBooks can then be transferred to your Kindle device either through a Wi-Fi network or through your Kindle's USB cable from your computer. The eBooks will not transfer to your Kindle on its 3G network. Also, only library eBooks and not library audio books will be available on the Kindle for downloading. Amazon and Overdrive do not provide support for library audio books on the Kindle.

1. The web site for eBooks is located at <http://wlnonline.lib.overdrive.com>. This is a different address than where you would access your patron account for print library books.

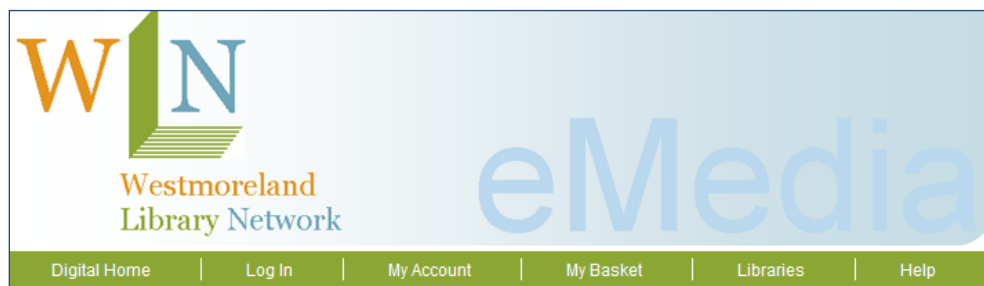

2. To look for an eBook you can either *Browse the Catalog* or do a *Quick Search*.

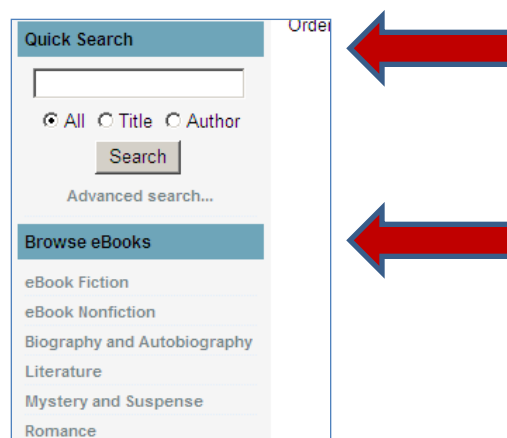

3. If you are interested in only seeing what eBooks are available, you can select the *Advanced Search* under the *Quick Search* box and scroll to the bottom and checkmark *Only Show Titles with Copies Available*. You can also change the *Format* from *All* to *Kindle Book*.

Advanced Search

Title:

Creator:

Keyword:

ISBN:

Format: **Kindle Book** 

Publisher: All publishers

Subject: All subjects

Awards: All awards

Date added to site:

Results per page: 10

Order by: Date added to site

Only show titles with copies available 

4. Next, make sure you select the **Kindle Book** version, and not the **Adobe EPUB** version. If the book is available, you can then select *Add to Basket*. If the book is not available, you can select *Join Waiting List*. This will place the book on hold for you, and you will receive an e-mail when the book is available for you.

The 4 Phase Man
by Richard Steinberg

Average rating: ★★★★★
Log In & rate this title.

The last man standing...At the height of the cold war, a few elite secret agents earned the title of "4 Phase Man." From Berlin to the Middle East, only two of them survived....The first man in...Once...

Available copies: 1
Library copies: 1

[Add to Wish List](#)

Kindle Book [Add to My Basket](#)

Use on: [Kindles and free Kindle apps](#)

Adobe EPUB eBook [Add to My Basket](#)

Use on: [eBook-compatible computers & devices](#)

The 100 Best Affordable Vacations
by Jane Wooldridge

Average rating: ★★★★★
Log In & rate this title.

Even in a weakened economy, research shows interest in travel is still strong and this book provides 100 great ways to satisfy your wanderlust without breaking the bank. Like the other books in this...

Available copies: 0
Library copies: 1

[Add to Wish List](#)

Kindle Book [Join Waiting List](#)

Use on: [Kindles and free Kindle apps](#)

5. Once you have selected *Add to Basket* you then have the option to *Continue Browsing* or to *Proceed to Checkout*.

The 4 Phase Man
Lending period: 14 days
Kindle Book Use on: [Kindles and free Kindle apps](#) [Remove](#)

[Continue Browsing](#) [Proceed to Checkout](#)

6. Next, choose *Westmoreland County Federated Library System* on the *Log In* page as your library.

Log In

To Log In, please select your library from the list below.

Library:

[select library] ▼

[select library]

Norwin Public Library

Penn Area Library

Westmoreland County Federated Library System



7. Type in your complete library card number, including any ending letter, without any spaces. If you receive any error messages about your card not being valid, contact your local library for assistance.

Westmoreland County Federated Library System
(If this is not your library, please [go back](#) and select again)

Library card number

Log In



8. You can choose the lending period of 14 or 7 days. Then select *Confirm Checkout*.

Check Out



[The 4 Phase Man](#)

Lending period: 14 day checkout ▼

Kindle Book Use on: [Kindles and free Kindle apps](#) [Remove](#)

My Account Notes:
Maximum checkouts allowed at one time on my library card: 5
Current number of titles checked out: 0
Checkouts remaining after this checkout: 4

Confirm Check Out



9. On the next screen, choose *Get for Kindle*.

Download

The following title(s) are now available for download:

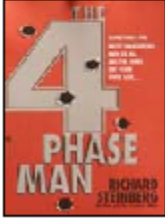

The 4 Phase Man
Kindle Book

Checked out on: Sep 24, 2011
Expires on: Oct 08, 2011

[Get for Kindle](#)

10. A new web page will open from www.amazon.com. Select *Get library book* on the right-hand side.

The 4 Phase Man [Kindle Edition]
[Richard Steinberg](#) (Author)

- Public library books require an active Wi-Fi connection for wireless delivery to a Kindle device. Library books will not be delivered via your Kindle's 3G connection.

[Get library book](#)

[How does this work?](#)

11. Next, sign in using your e-mail address and Amazon.com password. If you do not have an Amazon.com account, please type in your e-mail address and then select *No, I am a new customer* and choose *Sign in using our secure server*.

Sign In

What is your e-mail address?

My e-mail address is:

Do you have an Amazon.com password?

No, I am a new customer.

Yes, I have a password:

[Forgot your password?](#)

[Sign in using our secure server](#)

12. If you already have an Amazon.com account skip down to step 12. Otherwise, fill in the registration information with your name, e-mail address, and then create a password. Next choose *Create Account*. You do not need to give a credit card number to obtain an Amazon account.

Registration
New to Amazon.com? Register Below.

My name is:

My e-mail address is:

Type it again:

My mobile phone number is: (Optional)
[Learn more](#)

Protect your information with a password
This will be your only Amazon.com password.

Enter a new password:

Type it again:



13. If your Kindle is not registered with Amazon, the following screen will appear. Just select the *Register your device now* link near the bottom of the screen. You can also choose to obtain any free Kindle reading app.

Linda, we did not find a Kindle device or reading app registered to your Amazon account



Register a free Kindle reading app and try your purchase again:

- [Get Kindle for PC](#)
- [Get Kindle for iPhone](#)
- [Get Kindle for iPad](#)
- [Get Kindle for Android](#)
- [Get Kindle for BlackBerry](#)

Don't have a Kindle? [Learn more and get yours today](#)
Not Linda? [Sign in](#) and continue with your purchase
Have a new Kindle? [Register your device now](#) and continue with your purchase

Need more help? [Visit Kindle support](#)



14. Create a name for your Kindle, and then find the serial number on your device. This can be found by pressing the *Menu* button on your Kindle and then scrolling to and selecting the *Settings* link.

Register your new Kindle to continue with your Kindle Edition purchase.

To register, give your Kindle a name and enter the 16 digit serial number for your device. For latest generation Kindle devices, you can find the serial number on the first page of the Settings screen on your device.

Please click **Continue** to register your Kindle and complete your purchase.

Kindle Name:

Kindle Serial Number:

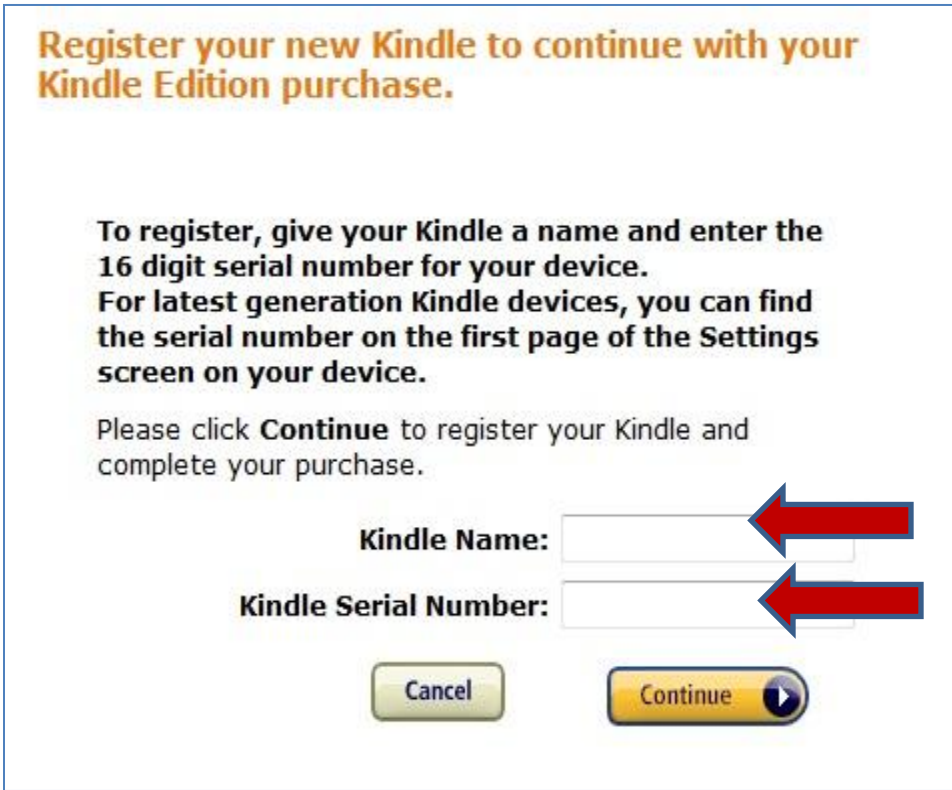

15. Once your Kindle is registered, you will see the next screen explaining how to transfer your book to your Kindle. This can be done through a Wi-Fi connection on your Kindle, or through your Kindle's USB cable from your computer to your Kindle.

Thanks, Linda!

Your public library book has been delivered to Linda. Your Kindle will download **A Thousand Tomorrows & Just Beyond The Clouds Omnibus (Cody Gunner)** the next time it connects to Wi-Fi. If you would like to manage your digital titles, go to [Manage Your Kindle](#).

To transfer to your device via USB, click **Download now** ([Learn more](#)).

You can also send your book to other registered devices at [Manage Your Kindle](#) or read on other devices using our [Free Kindle Reading Apps](#).

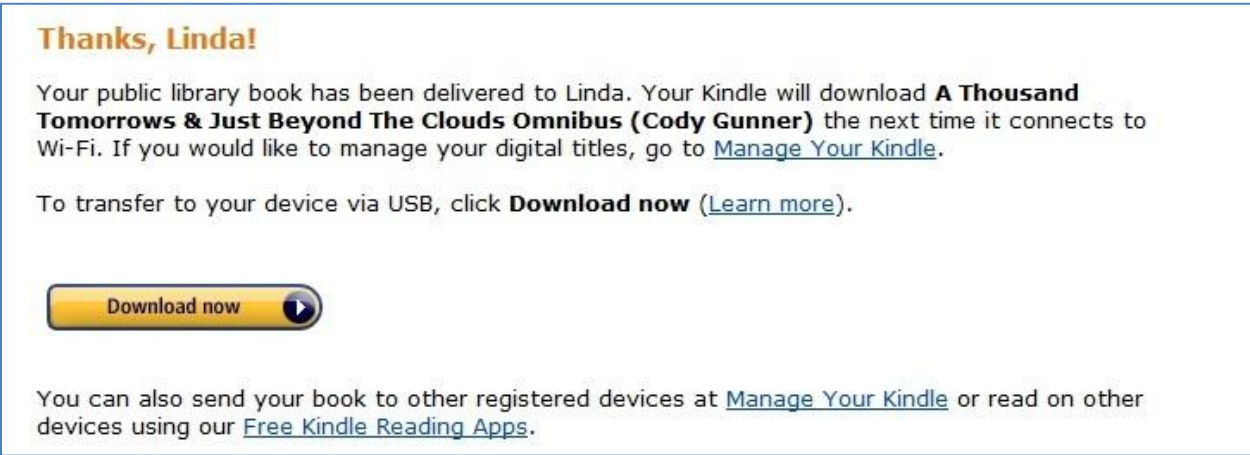

16. If a Wi-Fi connection is used, the book will appear on the home screen the next time the Kindle connects to the Wi-Fi network. The books will not transfer using the Kindle's 3G network.

17. If you wish to use the Kindle's USB cable, select the *Download now* icon to download the eBook to your computer.

Thanks, Linda!

Your public library book has been delivered to Linda. Your Kindle will download **A Thousand Tomorrows & Just Beyond The Clouds Omnibus (Cody Gunner)** the next time it connects to Wi-Fi. If you would like to manage your digital titles, go to [Manage Your Kindle](#).

To transfer to your device via USB, click **Download now** ([Learn more](#)).

 

You can also send your book to other registered devices at [Manage Your Kindle](#) or read on other devices using our [Free Kindle Reading Apps](#).

18. When prompted choose *Save*. This should save the book to the default location on your computer.

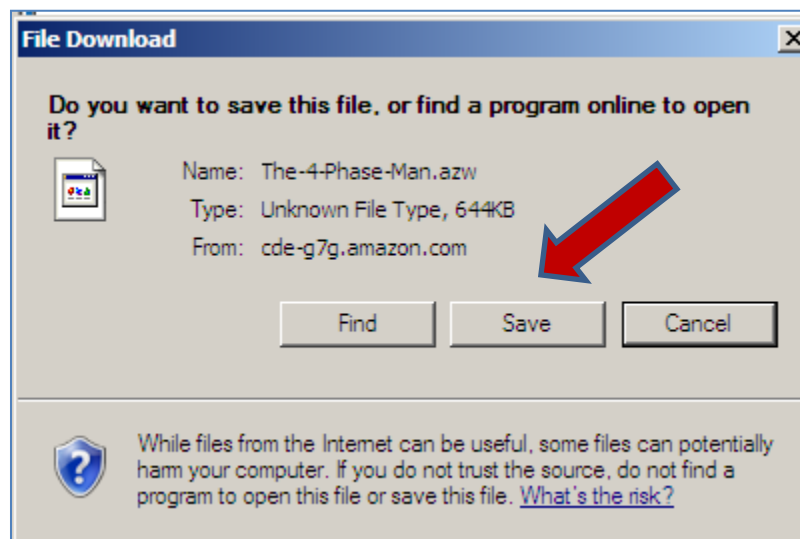

19. Connect your Kindle via its USB cable to your computer. You might need to wake-up the Kindle by sliding the power button to the right on the bottom of the Kindle. The first time you attached your Kindle to your computer, the Kindle's device drivers will need to install on your computer. Make sure you wait until the Kindle's device drivers are installed on your computer before you continue.

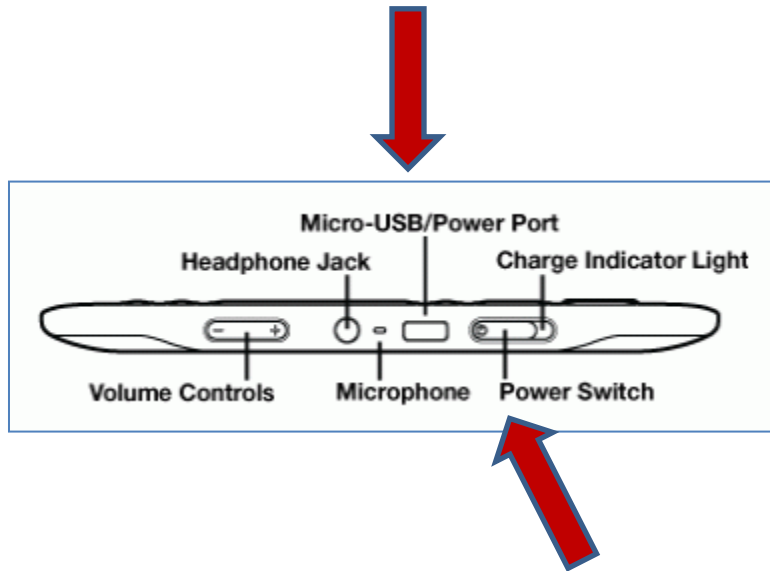

20. Once you have attached the Kindle to your computer, you will receive the following message on the Kindle about the USB Drive Mode: *If you want to read or shop on your Kindle while continuing to charge over USB, please keep the USB cable attached, but eject your Kindle from your computer. Do not eject your Kindle from your computer until you have copied the eBook file from your computer to your Kindle.*

21. Find your downloaded eBook file you saved on your computer. Then copy the downloaded file on your computer to the documents folder on your Kindle. The Kindle will be listed under the

various drives on your computer. The documents folder will be seen once you select the Kindle device.

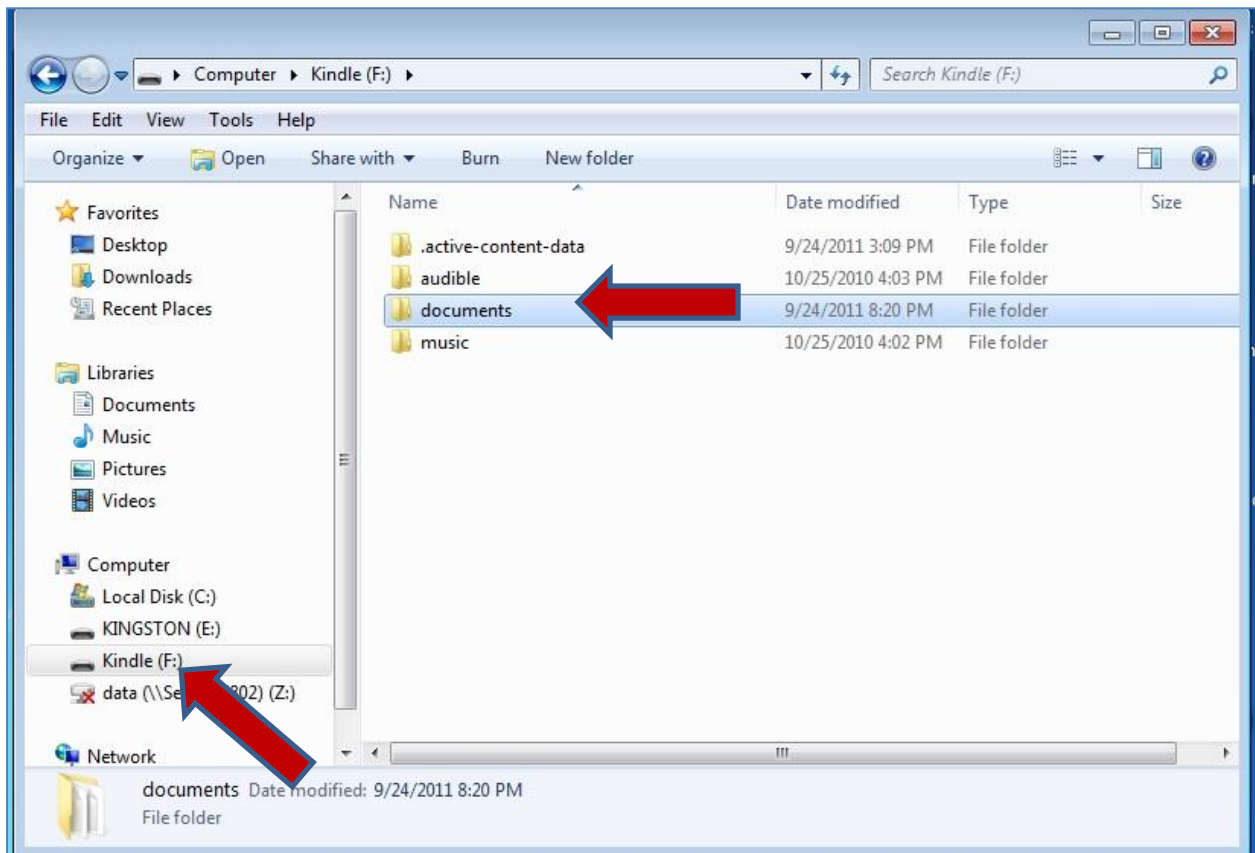

22. This will transfer the eBook to your device. To read the book, you need to eject your Kindle from your computer. To do this, select *My Computer* from your desktop and right-click on the Kindle device listed under *Devices with removable storage*.



23. On the next menu, select *Eject* to safely remove the Kindle from your computer.

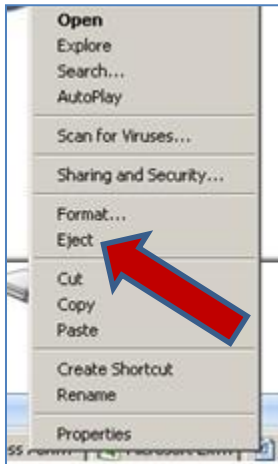

24. To read your library book, press the *Home* key and your title will appear on your Kindle. Using the arrow keys scroll down until your book title is underlined. Then press the enter key (the button in the center of the arrow keys). This will open your book!



25. To scroll through the book use the arrow keys on the side of the Kindle. Enjoy!

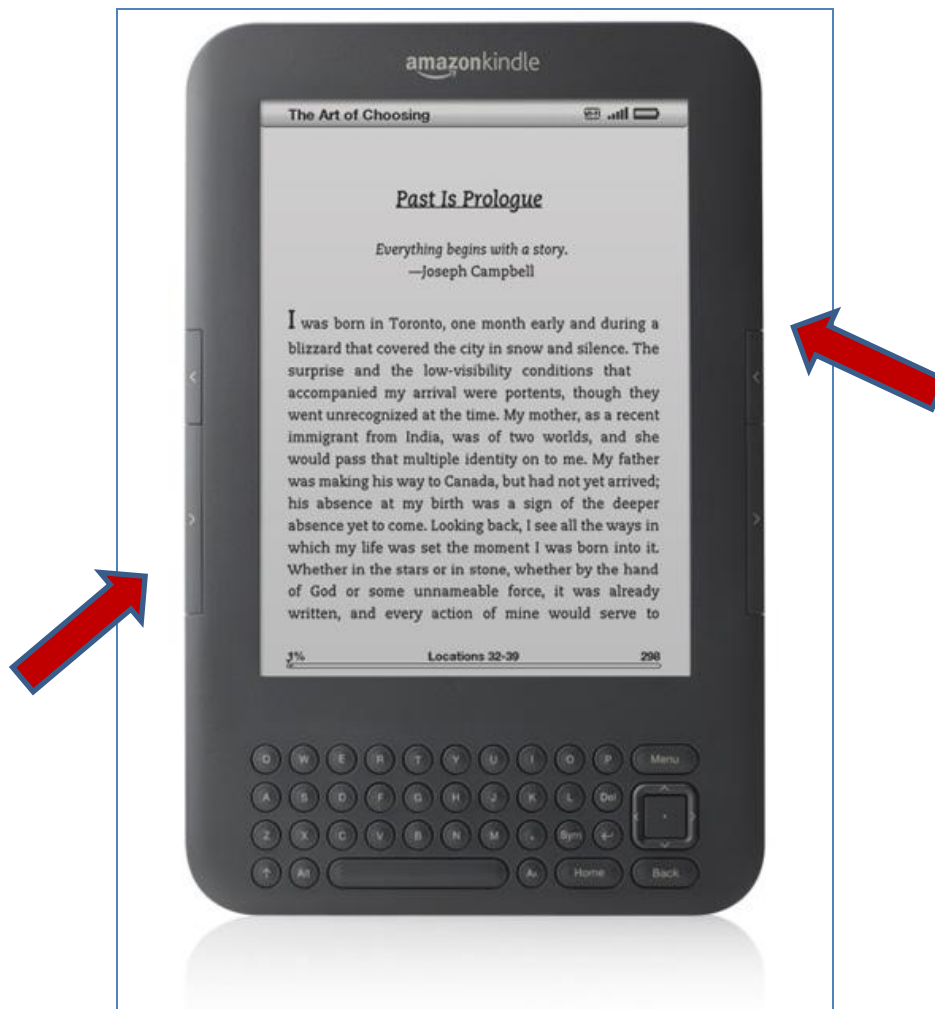

26. Your eBook loan period is either 1 or 2 weeks. The titles expire at the end of the loan period. You will not receive any late fees from eBooks. If you are not finished with the book by the end of the loan period, you will need to download the book again from the eMedia web site. The eBooks can not be renewed. There is a maximum limit of 5 eBooks checked out at any one time. You can place a maximum of 10 items on your hold list.

27. If you are finished with your eBook before the lending period is over, you can return the item early by accessing your Amazon account online and selecting *Manage Your Kindle*.

E-mail Address

Password

[Sign In](#)

Your Other Accounts

Your Seller Account
 Your Trade-In Account
 Corporate Customers
 Web Services Account
 Amazon Payments Account

[Sell Your Stuff](#)

Kindle Support



Kindle Help
[Kindle Help Home](#)
[Get to know your Kindle](#)
[Getting Started Guide](#)
[Kindle Troubleshooting](#)

Kindle Community
[Kindle Forum](#)
[Customer Service Forum](#)

[Manage Your Kindle](#)



28. Once in your Kindle library, select *Actions* next to the title you want to return, and then from the following menu select *Return this book*. You will receive a notification on your Kindle about this action. Once you have returned the book, you can delete it from your Kindle library and from your Kindle.

Your Kindle Library

View: OR [GO](#)

Showing 1 - 3 of 3 items

Title	Author	Date	
+ American Gospel: God, the Founding Fathers, and the Making of a Nation public library	Meacham, Jon	September 22, 2011	Actions...
+ The Ones Who Hit the Hardest: The Steelers, the Cowboys, the '70s, and the Fight for America's Soul public library	Millman, Chad, Coyne, Shawn	Sept	<ul style="list-style-type: none"> > Deliver to my... > Purchase this book > Download & transfer via USB > Return this book > Delete from library
+ Kindle User's Guide 3rd Edition	Amazon.com	Se	

« Previous | Page: 1 | Next »

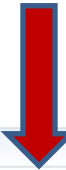

Greensburg Hempfield Area Library Home Page